

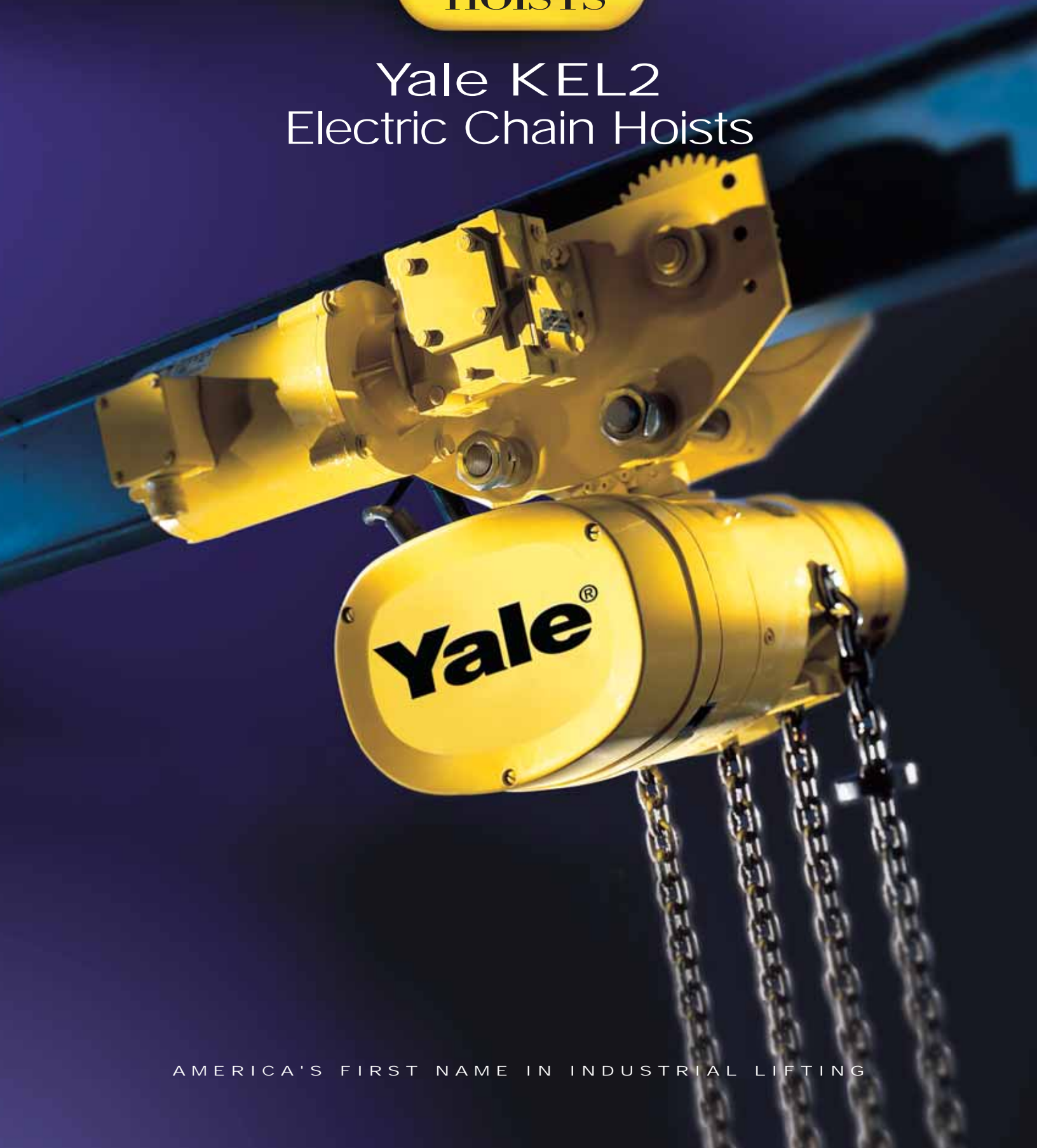

Yale KEL2
Electric Chain Hoists



AMERICA'S FIRST NAME IN INDUSTRIAL LIFTING

Yale® KEL2 Electric Chain Hoists



Yale Works, 1920
Stamford, Connecticut

One of the oldest hoist manufacturers in the world. Yale's leadership in the hoisting industry was recognized from the earliest times. In fact, the Yale name has stood for quality for over 100 years!

It all began in 1875, when Linus Yale invented the Differential Hoist launching the monorail hoist industry. Since then, the Yale company has contributed numerous advancements, as well as a continued introduction of safety-oriented accessories like the Weston Screw Load Brake, first introduced way back in 1879.

Quality engineered and performance tested, Yale products, like the company itself, are built to last.

Yale hoists come with two choices of load chain; roller and link. Roller chain provides smoother, quieter operation for light to medium duty applications. Roller chain models are available only in hook suspension. Link chain hoists are ideal for heavier service applications requiring repeated lifting cycles. All link chain models are available in either hook or lug suspension.

All Yale electric hoists are equipped with a heavy duty, positive acting, short-stroke DC rectified disc motor brake. The brake is rated at 150% torque to stop and hold the load. In addition, all hoists are provided with a Weston-type mechanical load brake for load lowering control and as a backup to the hoist motor brake. An overload device is also standard on all Yale Electric Chain Hoists. The overload device protects the hoist, operator and supporting structure by preventing dangerous overloads.

A wide variety of trolleys are provided for both hook and lug-suspended hoists. Trolleys are available in push, hand-gear and motor-driven versions. Hook-on trolleys are available in either push or hand-gear versions.

Rigid Mount trolleys are available in push, hand-gear and motor-driven versions.

Yale hoists are available in a variety of controls to meet the specific need of your application. The standard control is single speed with options available for two speed and variable frequency.

All Yale electric hoists and/or motor-driven trolleys are CSA approved.

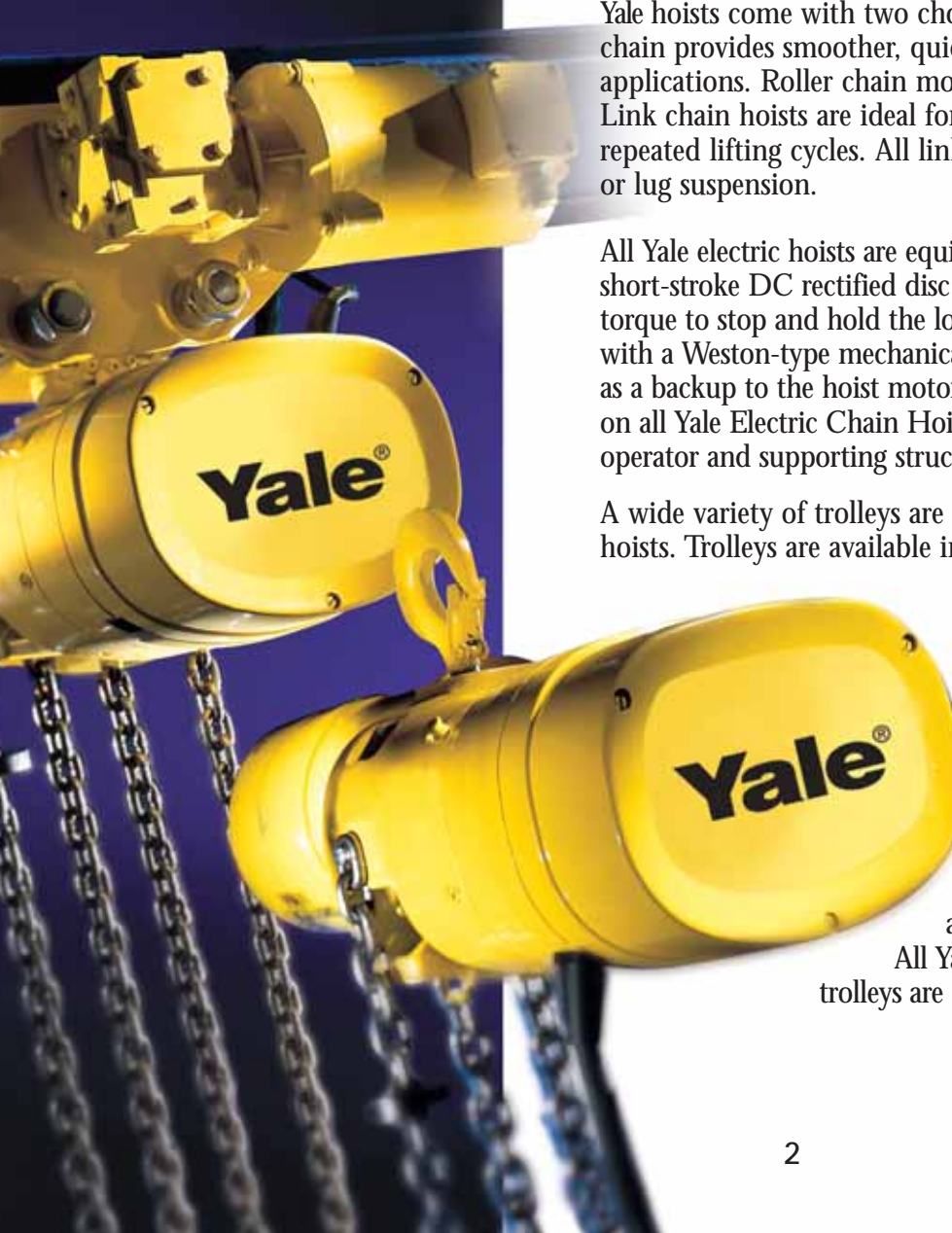

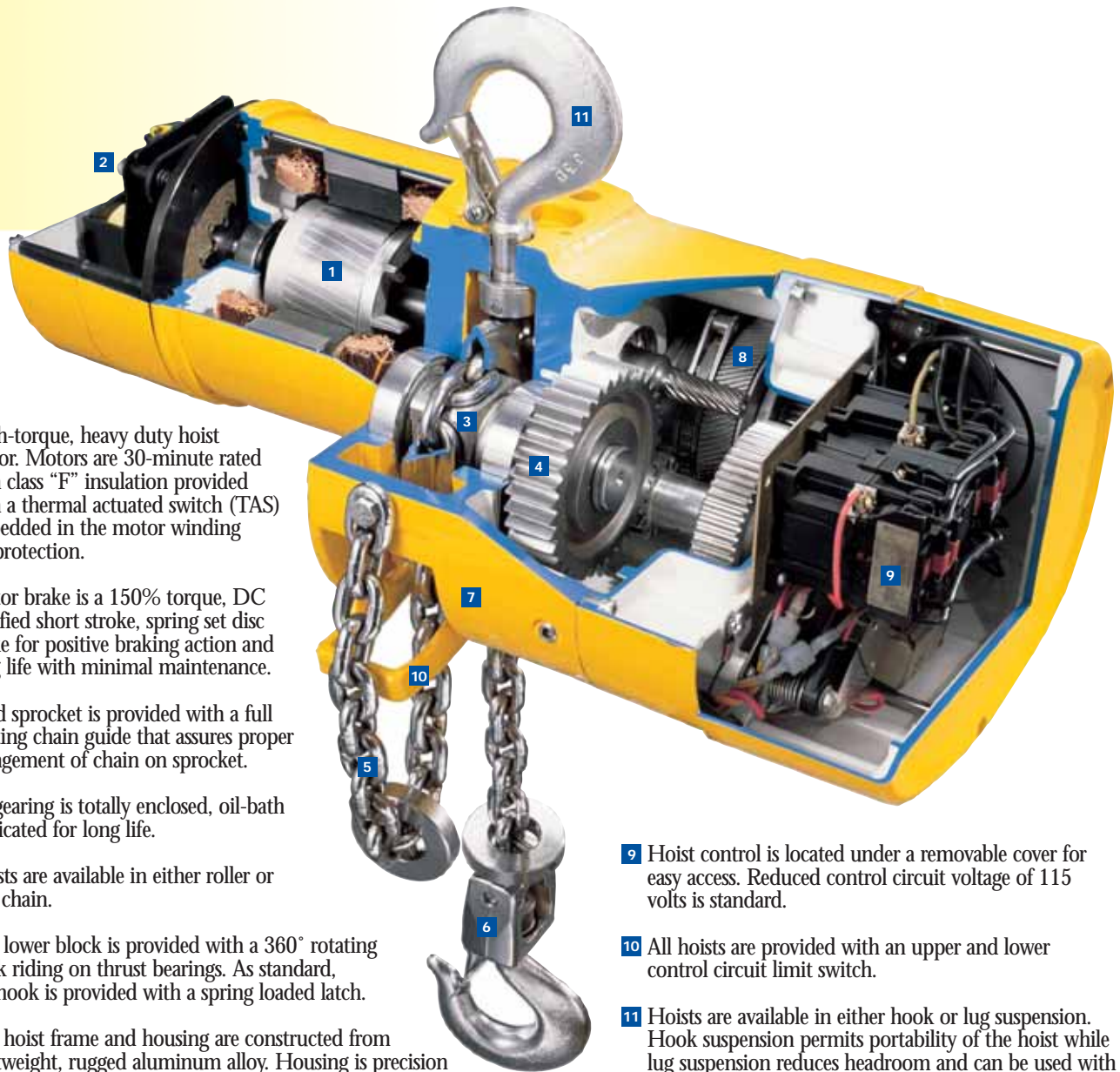

1 High-torque, heavy duty hoist motor. Motors are 30-minute rated with class “F” insulation provided with a thermal actuated switch (TAS) embedded in the motor winding for protection.

2 Motor brake is a 150% torque, DC rectified short stroke, spring set disc brake for positive braking action and long life with minimal maintenance.

3 Load sprocket is provided with a full floating chain guide that assures proper engagement of chain on sprocket.

4 All gearing is totally enclosed, oil-bath lubricated for long life.

5 Hoists are available in either roller or link chain.

6 The lower block is provided with a 360° rotating hook riding on thrust bearings. As standard, the hook is provided with a spring loaded latch.

7 The hoist frame and housing are constructed from lightweight, rugged aluminum alloy. Housing is precision machined for accurate gear and bearing alignment.

8 All hoists are provided with mechanical load brake and overload protection. The load brake provides load lowering control and a backup for the DC disc motor brake. Overload protection prevents lifting loads beyond the hoist’s load range which may damage the hoist.

9 Hoist control is located under a removable cover for easy access. Reduced control circuit voltage of 115 volts is standard.

10 All hoists are provided with an upper and lower control circuit limit switch.

11 Hoists are available in either hook or lug suspension. Hook suspension permits portability of the hoist while lug suspension reduces headroom and can be used with any of our rigid-mount trolleys.

(Not Shown) Standard push-button control station is contoured for operator comfort allowing easy one-handed sure grip control and provided with a weatherproof NEMA-4X enclosure. The push-button cable is provided with built-in strain relief to help prevent cable damage.

Yale® Hook & Lug Mounted Hoists

HOOK & LUG MOUNTED HOISTS WITH PUSH AND HAND-GEARED TROLLEYS

One and Two Speed Hoists

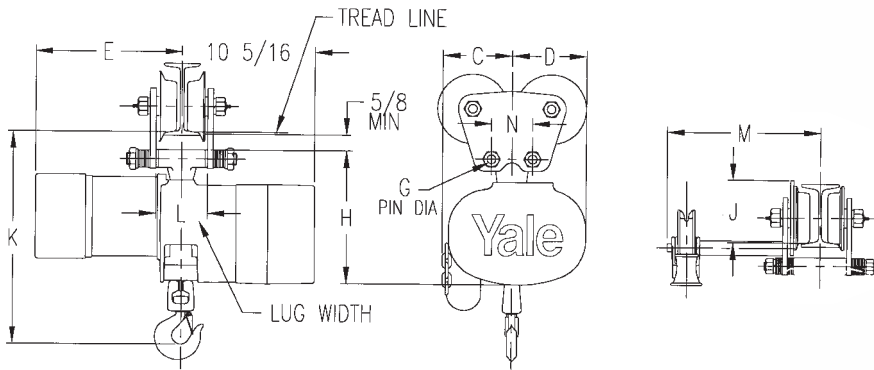

Lug Mounted



CATALOG NUMBERS, SPECIFICATIONS & DIMENSIONS (Push and hand-gear trolleys)

Capacity (tons)	Lift Speed (fpm)	Motor H.P.	Electric Current Phase	Parts of Chain	Hoist Catalog Number	Net Wt. (lbs)	Dimensions			
							A (in)	B (in)	C (in)	D (in)
1/4	16	1/4*	Single	1	KELB1/4-10**16S1	79	15 3/4	11 1/16	5 1/8	6 5/16
	32	1/2	Three		KELB1/4-10**32S1	82				
	64	1	—		KELB1/4-10**64S1	78				
1/2	16	1/2	Single	1	KELB1/2-10**16S1	82	15 3/4	11 1/16	5 1/8	6 5/16
	32	1	Three		KELB1/2-10**32S1	83				
	32	2 1/2	—		KELB1-10**32S1	96				
1	8	1/2	Single	1	KELB1-10**8S1	90	16 9/16	11 1/16	5 1/8	6 5/16
	16	1	Three		KELB1-10**16S1	91				
	32	2 1/2	—		KELB1-10**32S1	96				
2	4	1/2	Single	2	KELB2-10**4S2	115	22 1/4	12 13/16	6 7/16	4 7/8
	8	1	Three		KELB2-10**8S2	116				
	16	2 1/2	—		KELB2-10**16S2	117				
3	5	1	Single	3	KELB3-10**5S3	156	24	14 3/8	7 3/4	7 3/8
	10	2 1/2	Three		KELB3-10**10S3	166				
	10	2 1/2	—		KELB3-10**10S3	166				

* Two speed hoist has a 1/2 HP motor

**To complete the model number insert TH, PT, RT, GT, LG, in place of the ** when ordering.

Standard Lift: 10 Feet. Available Voltages 115/230-1-60 (1/2 and 1 hp only). 200/208-3-60, 230/460-3-60, 575-3-60. Two speed units available 3 phase only.

Yale® Hook & Lug Mounted Hoists

HOOK & LUG MOUNTED HOISTS WITH PUSH AND HAND-GEARED TROLLEYS

One and Two Speed Hoists

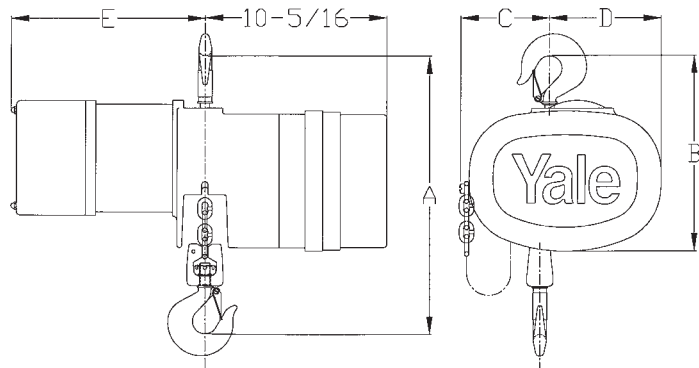

Hook Mounted



CATALOG NUMBERS, SPECIFICATIONS & DIMENSIONS (Push and hand-gearred trolleys)

E		G Pin Diameter (in)	H (in)	J Max. (in)	K (in)	L (in)	M	
One Speed (in)	Two Speed (in)						(std. flange width) (in)	N (in)
10 ⁷ / ₈	—	5/8	9 ¹⁵ / ₁₆	3 ⁵ / ₈	15 ³ / ₈	3 ⁵ / ₈	—	3 ¹ / ₈
11	—							
11 ³ / ₈	—							
11	11 ¹ / ₂							
11	12 ¹ / ₁₆							
11 ³ / ₈	—	5/8	9 ¹⁵ / ₁₆	3 ⁵ / ₈	15 ³ / ₈	3 ⁵ / ₈	—	3 ¹ / ₈
11	11 ¹ / ₂							
12 ¹ / ₈	—							
11 ¹ / ₂	12 ¹ / ₁₆							
11 ³ / ₈	—							
11	11 ¹ / ₂	5/8	9 ¹⁵ / ₁₆	3 ⁵ / ₈	16 ⁵ / ₁₆	3 ⁵ / ₈	9 ³ / ₄	3 ¹ / ₈
12 ¹ / ₈	—							
11 ¹ / ₂	12 ¹ / ₁₆							
—	—							
12	14							
11 ³ / ₈	—	1	10 ¹¹ / ₁₆	4 ³ / ₈	20 ¹ / ₁₆	4 ³ / ₈	10 ¹ / ₄	5
11	—							
12 ¹ / ₈	—							
11 ¹ / ₂	12 ¹ / ₁₆							
—	—							
12	14	1 ¹ / ₄	12 ⁷ / ₈	6	24 ¹ / ₂	6	18 ³ / ₈	6
12 ¹ / ₈	—							
11 ¹ / ₂	12 ¹ / ₁₆							
—	—							
12	14							

Yale® Lug Hoists with Motor-Driven Trolley

ONE & TWO SPEED HOISTS

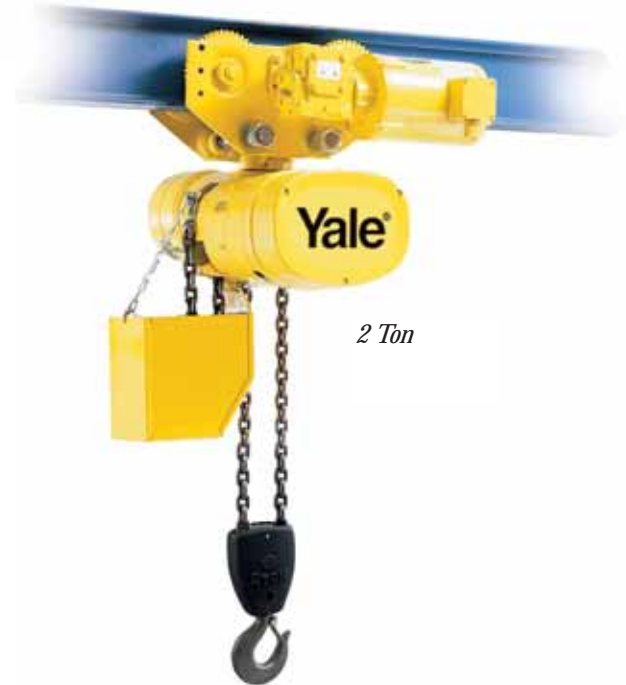
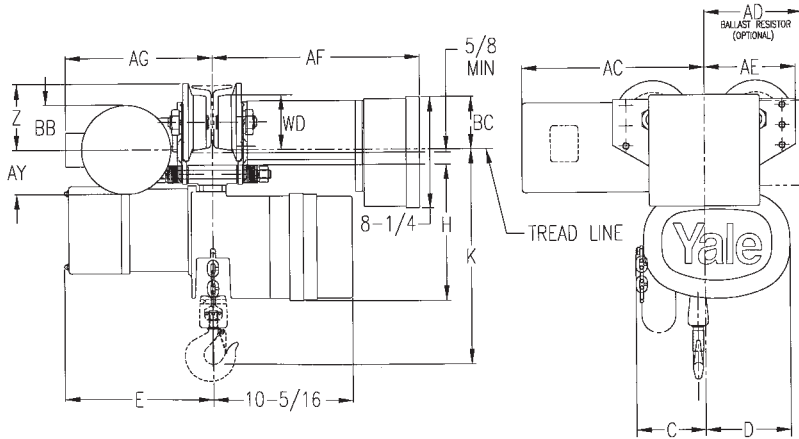

2 Ton

1/4 - 1 Ton & 2 Ton Trolley

CATALOG NUMBERS, SPECIFICATIONS & DIMENSIONS

Capacity (tons)	Lift Speed (fpm)	Motor H.P.	Electric Current Phase	Parts of Chain	Hoist Catalog Number	Net Wt. (lbs)	C (in)	D (in)	E		H (in)	K (in)	Z (in)
									One Speed (in)	Two Speed (in)			
1/4	16	1/4*	SINGLE	1	KELB1/4-10**16S1	164	5 1/8	6 5/16	10 7/8	—	6 15/16	15 3/8	4 7/8
	32	1/2	SINGLE		KELB1/4-10**32S1	167			11 3/8	—			
	64	1	THREE		KELB1/4-10**64S1	163			11	11 1/2			
1/2	16	1/2	SINGLE	1	KELB1/2-10**16S1	167	5 1/8	6 5/16	11 3/8	—	9 15/16	15 3/8	4 7/8
	32	1	SINGLE		KELB1/4-10**32S1	168			11 1/2	12 1/16			
1	8	1/2	SINGLE	1	KELB1-10**8S1	175	5 1/8	6 5/16	11 3/8	—	9 15/16	15 3/8	4 7/8
	16	1	SINGLE		KELB1-10**16S1	176			11	11 1/2			
	32	2 1/2	THREE		KELB1-10**32S1	181			11 1/2	12 1/16			
2	4	1/2	SINGLE	2	KELB2-10**4S2	210	6 7/16	4 7/8	11 3/8	—	10 11/16	20 1/16	4 7/8
	8	1	SINGLE		KELB2-10**8S2	211			11	—			
	16	2 1/2	THREE		KELB2-10**16S2	212			11 1/2	12 1/16			
3	5	1	SINGLE	3	KELB3-10**5S3	296	7 3/4	7 3/8	12 1/8	—	12 7/8	24 1/2	4 7/8
	10	2 1/2	THREE		KELB3-10**10S3	306			11 1/2	12 1/16			

* Two speed hoist has a 1/2 HP motor. **To complete the model number insert TH, PT, RT, GT, LG, in place of the ** when ordering.

Standard Lift: 10 Feet. Available Voltages 115/230-1-60 (1/2 and 1 hp only). 200/208-3-60, 230/460-3-60, 575-3-60.

Two speed units available 3 phase only.

Yale® Lug Hoists with Motor-Driven Trolley

ONE & TWO SPEED HOISTS

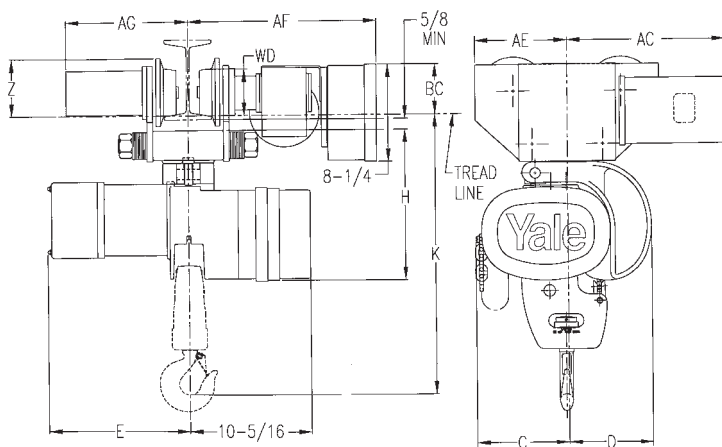

3 Ton Trolley

CATALOG NUMBERS, SPECIFICATIONS & DIMENSIONS

AC (in)	AE (in)	AD (in)	AF Max. (in)	AG Max. (in)	AY (in)	BB Max. (in)	BC (in)	WD (in)	Min. Radius (ft)	Std. Flange Width Adj. (in)
12	6 ⁷ / ₈	8 ³ / ₁₆	16 ⁷ / ₈	12 ¹ / ₂	2 ⁹ / ₁₆	3 ¹ / ₈	1 ¹³ / ₁₆	4	3	3 - 5
12	6 ⁷ / ₈	8 ³ / ₁₆	16 ⁷ / ₈	12 ¹ / ₂	2 ⁶ / ₁₆	3 ¹ / ₈	1 ¹³ / ₁₆	4	3	3 - 5
12	6 ⁷ / ₈	8 ³ / ₁₆	16 ⁷ / ₈	12 ¹ / ₂	2 ⁹ / ₁₆	3 ¹ / ₈	1 ¹³ / ₁₆	4	3	3 - 5
12	7 ⁹ / ₁₆	8 ³ / ₁₆	16 ⁷ / ₈	12 ¹ / ₂	1 ¹⁵ / ₁₆	2 ¹ / ₁₆	2 ⁷ / ₁₆	4	4	3 ⁵ / ₈ - 6
13 ¹ / ₂	7 ¹³ / ₁₆	8 ³ / ₁₆	16 ¹³ / ₁₆	5 ⁷ / ₈	—	—	2 ¹ / ₈	4	4	4 - 6 ¹ / ₄

Yale® Hook Suspension Trolleys

HOOK SUSPENSION TROLLEYS *(For use only with hook-type hoists)*

Yale hook suspension trolleys are available in push and hand-gear versions to run on either American Standard Section I-Beams or wide flange beams.

The trolley sides are of all-steel construction for maximum strength. The wheels are steel with hardened treads and roller bearings for easy traversing and long life. Self-aligning frames keep the load equally distributed, and are adjustable to fit several sizes of beams.

Push trolleys are an economical alternative for low duty cycle, lighter capacity applications with lifts under 20 feet. Push trolleys are available in capacities from 1/4 to 3 tons. 1/4 thru 2 ton capacity are metric rated.

Hand-gear trolleys are designed for applications requiring close control of horizontal movement of the hoist and its load. They are also ideal for those applications where an operator shouldn't be near or touch the load to move or position it. The trolleys are available in capacities from 1 thru 3 tons. The 1 and 2 ton trolleys are metric rated.



CATALOG NUMBERS AND SPECIFICATIONS

Capacity (tons)	Push Trolley		Hand-Gear Trolley*		Min. Beam Depth** (in)	Adjustable For Flange Widths (in)	Min. Radius Curve Trolley Will Negotiate
	Catalog Number	Net Wgt. (lbs.)	Catalog Number	Net Wgt. (lbs.)			
† 1/4	80 80WFA	13 14	—	—	4	2 5/8 to 4 5/8 5 to 7	2' - 6"
† 1/2	81 81WFA	13 14	—	—	4	2 5/8 to 4 5/8 5 to 7	2' - 6"
† 1	82	25	82G	39	5	3 to 5 5 to 7 7 to 9	3' - 0"
	82WFA	26	82GWFA	38			
	82WFB	27	82GWFB	40			
† 2	83	35	83G	48	6	3 3/8 to 6 6 to 8 8 to 10	4' - 0"
	83WFA	36	83GWFA	49			
	83WFB	37	83GWFB	50			
3	905480	41	905490	65	6	3 3/8 to 6 6 1/8 to 8 7/8 9 to 11	4' - 0"
	905481	43	905491	67			
	905482	44	905492	68			

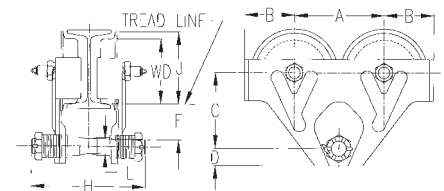

Push Type Trolley 1/4, 1/2, 1 & 2 Ton

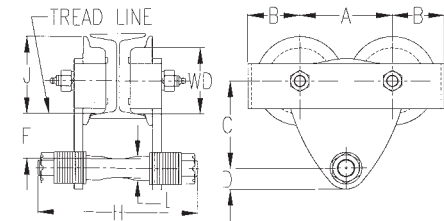

3 Ton

* Hand-gear trolleys have standard chain drop of 9'-6". Longer chain available. ** When used on smallest I-beam size, beam must be free of all obstructions such as clips, suspension bolts and nuts. If beam is welded to cross trusses, spacers must be used between top of beam and truss to provide wheel flange clearance. Track must be supported from ends only as wheel flanges will be above top of I-beam. † Metric Rated Trolleys.

OUTLINE DIMENSIONS (IN)

Cap. (tons)	Catalog Number	A	B	C	D	WD	F*	H**	J	L	Max. M***
1/4	80	4 3/8	2 7/16	4 1/8	1	3 1/8	2 1/8	7 9/16	3 11/16	7/8
1/2	81	4 3/8	2 7/16	4 1/8	1	3 1/8	2 1/8	7 9/16	3 11/16	7/8
1	82	6 7/8	3 9/16	5 1/8	1 1/8	4	2 19/32	8 1/4	4 9/16	1
	82G	6 1/8	3 9/16	5 1/8	1 1/8	4	2 39/64	8 1/4	5	1	10 3/16
2	83	6 7/8	3 13/16	5 3/4	1 5/16	4 15/16	2 23/32	8 3/4	5 1/2	1 1/8
	83G	6 7/8	3 13/16	5 3/4	1 5/16	4 15/16	2 23/32	8 3/4	5 13/16	1 1/8	10 9/16
3	905480	6 7/8	4 3/8	6	1 5/8	4 15/16	2 53/64	12	5 13/16	1 7/16
	905490	6 7/8	4 3/8	6	1 5/8	4 15/16	2 53/64	12	5 13/16	1 7/16	18 5/16

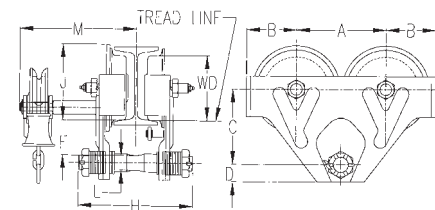

Hand-Gear Trolley 1, 2 & 3 Ton

* Dimension "F" is based on standard BUDGIT® Hoist hook and smallest size beam on which trolley will operate. Dimension decreases slightly for larger beam sizes.

** Dimension "H" is based on standard trolley, WFA and B trolleys have greater dimensions.

*** Dimension "M" occurs on the smallest beam only. On larger beams, this dimension is increased by the difference in flange width.

Yale® Rigid Mount Trolleys

RIGID MOUNT TROLLEYS (For use only with lug-suspended hoists)

Push and Hand-Geared Type (Capacities: 1/4 thru 3-ton)

These Rigid Mount Trolleys are designed especially for use with lug suspended hoists. The trolleys attach directly to lug brackets on the hoists, thereby forming integral trolley-hoist combinations, offering close headroom dimensions – making the trolley-hoist ideal for applications where distance from floor to I-beam is limited.



The trolleys are of all-steel construction to provide maximum strength. Wheels have hardened treads, ensuring long life, and operate on ball bearings for easy travel. Pressure fittings are provided in wheel axles to simplify lubrication.

On hand-gear models, the hand chain operated wheel turns a pinion which meshes with steel gears for ease of operation and accurate spotting. The chain guide keeps the chain aligned with the wheel and helps prevent fouling. The wheel gears and drive pinion have machine cut teeth.

Anti-tilt rollers are provided on hand-gear trolleys to eliminate the tilting of trolley on beam when operating with a light load or without a load.

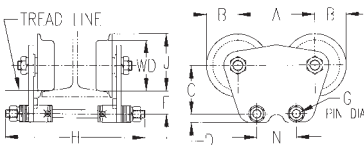

Push Type Trolley 1/4, 1/2 & 1 Ton

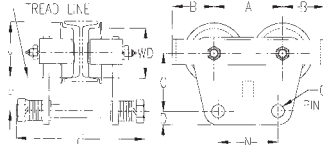

2 & 3 Ton

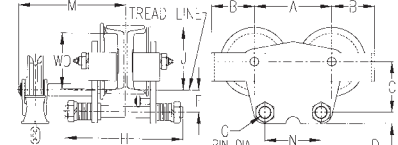

Hand-Geared Trolley 1/2, 1, 2 & 3 Ton

RIGID MOUNT TROLLEYS – PUSH & HAND-GEARED

Cap. (tons)	Push Trolley		Hand-Geared Trolley*		** Min. Beam Depth (in)	Adj for Flange Widths (in)	Min. Curve Rad	OUTLINE DIMENSIONS (IN)										
	Cat No.	Net Wt. (lbs)	Cat No.	Net Wt. (lbs)				A	B	C	D	WD	**** F Max.	G DIA.	H	J Max.	M Max.	N
1/2	905401	15	—	—	4	2 ⁵ / ₈ to 4 ⁵ / ₈	2' 6"	4 ³ / ₈	2 ⁵ / ₈	3 ³ / ₁₆	1 ¹ / ₁₆	3 ¹ / ₈	1 ⁵ / ₈	5 ⁵ / ₈	8 ¹ / ₈	3 ¹¹ / ₁₆	—	3 ¹ / ₈
1	905402	23	—	—	5	3 to 5	3' 6"	6 ¹ / ₈	2 ⁹ / ₁₆	3 ⁷ / ₈	1 ¹ / ₁₆	4	1 ⁷ / ₈	5 ⁵ / ₈	8 ⁷ / ₈	5	—	3 ¹ / ₈
	905405	24	—	—		5 ¹ / ₄ to 7 ³ / ₈									11 ¹ / ₈		—	
	—	—	905411	40		3 to 5									8 ⁷ / ₈		9 ³ / ₄	
	—	—	905413	41		5 ¹ / ₄ to 7 ³ / ₈									11 ¹ / ₈		11 ¹ / ₈	
2	905403	43	905412	57	6	3 ³ / ₈ to 6	4' 0"	6 ⁷ / ₈	3 ¹³ / ₁₆	4 ⁷ / ₁₆	1	4 ¹⁵ / ₁₆	2	1	10 ¹ / ₈	5 ¹³ / ₁₆	10 ¹ / ₄	5
	905406	44	905414	58		6 ¹ / ₄ to 8 ⁷ / ₈									13		11 ⁷ / ₈	
3	905404	50	905417	65	6	3 ³ / ₈ to 6	4' 0"	6 ⁷ / ₈	4 ³ / ₁₆	5 ³ / ₄	1 ³ / ₈	4 ¹⁵ / ₁₆	3 ¹ / ₄	1 ¹ / ₄	12 ³ / ₄	5 ¹³ / ₁₆	18 ³ / ₈	6
	905407	52	905418	67		6 ¹ / ₈ to 8 ⁷ / ₈									15 ³ / ₄		19 ⁷ / ₈	
	905408	54	905419	69		9 to 11									17 ⁷ / ₈		21 ¹ / ₈	

Heavy Duty Rigid Mount Trolleys

HEAVY DUTY RIGID MOUNT TROLLEYS – PUSH & HAND-GEARED

1	900211	35	900261	50	6	3 to 5	3' 0"	7 ⁵ / ₈	3	3 ⁷ / ₈	3 ³ / ₄	4	1 ⁷ / ₈	5 ⁵ / ₈	8 ⁷ / ₈	4 ⁷ / ₈	10 ⁹ / ₁₆	3 ¹ / ₈
	900212	38	900262	53		5 ¹ / ₈ to 7 ¹ / ₄									11 ¹ / ₄		11 ¹ / ₁₆	
	900213	41	900263	56		7 ¹ / ₂ to 9 ¹ / ₈									12 ³ / ₄		12 ⁵ / ₈	
2	900221	45	900271	60	6	3 ³ / ₈ to 6	4' 0"	9 ¹ / ₈	3	4 ¹ / ₈	1 ⁵ / ₁₆	4	2 ¹ / ₈	1	9 ¹ / ₂	4 ⁷ / ₈	10 ¹ / ₈	5
	900222	48	900272	63		6 ¹ / ₄ to 8 ⁵ / ₈									12 ¹ / ₈		11 ³ / ₈	
	900223	51	900273	66		8 ⁷ / ₈ to 11 ¹ / ₄									14 ³ / ₄		12 ¹ / ₁₆	
3	900231	55	900281	70	6	4 to 6 ¹ / ₄	4' 0"	9 ¹ / ₈	3 ¹ / ₄	4 ¹ / ₂	1 ³ / ₈	4	2 ¹ / ₂	1 ¹ / ₄	12	4 ⁷ / ₈	16 ¹ / ₂	6
	900232	58	900282	73		6 ³ / ₈ to 8 ⁵ / ₈									14 ³ / ₈		17 ¹ / ₁₆	
	900233	62	900283	77		8 ³ / ₄ to 11									16 ³ / ₄		18 ⁷ / ₈	

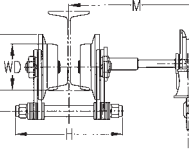
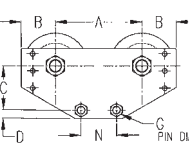
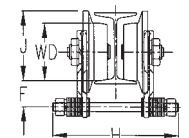

* Hand-gear trolleys have standard hand chain drop of 9' - 6". Longer chain available. ** When used on smallest I-Beam size, beam must be free of all obstructions such as clips, suspension bolts and nuts. *** For 1/4 and 1/2 ton applications on wider flange beams, mount on 1 ton trolleys. **** Dimension "F" is based on largest size beam on which trolley will operate. Dimension increases slightly for each of the smaller beam sizes.

Yale® Motor-Driven Trolleys

MOTOR-DRIVEN TROLLEYS *(For use only with lug-suspended hoists)*

Yale motor-driven trolleys are designed to operate with Yale lug mounted hoists...attaching directly to the hoist suspension lug, forming an integral hoist/trolley combination. Motor-driven trolleys are ideal for heavier duty cycles or applications with heavier capacities and longer lifts and applications where the operator can not touch or be near the load.

Motor-driven trolleys are offered in capacities from 1/4 to 3 tons to cover the entire range of Yale electric chain hoists. The trolleys are provided with a four button pendant station as standard for controlling the hoist and trolley motions. The pendant station uses control voltage from the hoist control.



Some of the superior construction features of the Yale Motor-driven trolleys are:

- Steel frame side plates extend beyond the wheels for end stop contact. Side plates have tapped holes for collector bracket attachment.
- Wheels are forged heat-treated steel with contour tread for use on American Standard I-Beams or wide flange beams.
- Traverse motor is 30-minute rated, totally enclosed non-ventilated with class "F" insulation and TAS as standard.
- Traverse gearing is housed in a heavy duty right angle drive reducer with output pinion meshing with machine cut wheel gears.
- Trolley controls are housed in a NEMA 1 enclosure mounted on the trolley side for easy access. The controls include a reversing contactor, terminal strip and NEMA 4X pendant station with hoist and trolley push-button controls as standard.

SIZES, CATALOG NUMBERS & SPECIFICATIONS

MOTOR-DRIVEN TROLLEY FOR USE WITH SINGLE OR TWO SPEED HOISTS

Catalog Number	Net Wt.	Std. Width Adjustment	Extended Adjustments with price added to std.		Trolley Speed	Optional Standard Speeds (fpm)	Special Speed (fpm)	Motor H.P.
			1st Ext. Flange Adj.	2nd Ext. Flange Adj.				
1/4 to 1 Ton Capacity								
MDT01	85#	3 ³ / ₈ " - 5"	5 ¹ / ₈ " - 7 ¹ / ₄ "	7 ¹ / ₂ " - 9 ¹ / ₈ "	75 fpm	50 & 100	25, 150	1/4
2 Ton Capacity								
MDT02	95#	3 ⁵ / ₈ " - 6"	6 ¹ / ₄ " - 8 ⁵ / ₈ "	8 ⁷ / ₈ " - 11 ¹ / ₄ "	60 fpm	40 & 80	30, 120	1/4
3 Ton Capacity								
MDT03	140#	4" - 6 ¹ / ₄ "	6 ³ / ₈ " - 8 ⁵ / ₈ "	8 ³ / ₄ " - 11"	50 fpm	75 & 100	25, 125	1/4

Always specify voltage when ordering. Voltages available: 115/230-1-60, 208-230/460-3-60, 575-3-60

115/230-1-60 is not available on trolleys for two speed hoists or two speed trolleys.

Two speed trolleys have a 3:1 speed ratio. Standard pendant drop from trolley is 7 feet. Longer cables are available.

Trolleys are equipped with 3-foot length power supply cable. Longer lengths are available.

HEAVY DUTY RIGID MOUNT TROLLEYS

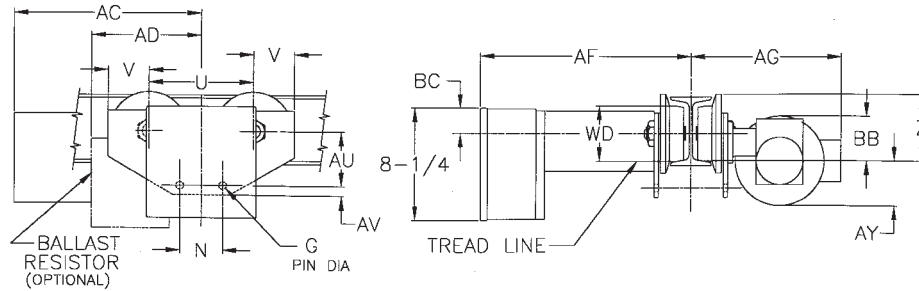

1/4 - 1 Ton & 2 Ton Trolley

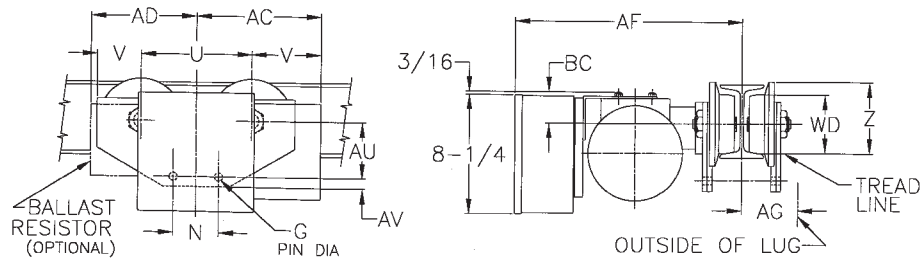

3 Ton Trolley

OUTLINE DIMENSIONS

Dimensions	1/4 thru 1 Ton Capacity	2 Ton Capacity	3 Ton Capacity
AC	12"	12"	13 ¹ / ₂ "
AD	8 ³ / ₁₆ "	8 ³ / ₁₆ "	8 ³ / ₁₆ "
AF Max.	16 ⁷ / ₈ "	16 ⁷ / ₈ "	16 ¹³ / ₁₆ "
AG Max.	12 ¹ / ₂ "	12 ¹ / ₂ "	5 ⁷ / ₈ "
AU	3 ⁷ / ₈ "	4 ¹ / ₈ "	4 ¹ / ₂ "
AV	3/4"	1 ¹⁵ / ₁₆ "	1 ³ / ₈ "
AY	2 ⁹ / ₁₆ "	1 ¹⁵ / ₁₆ "	—
BB Max.	3 ¹ / ₈ "	2 ¹ / ₁₆ "	—
BC	1 ¹³ / ₁₆ "	2 ⁷ / ₁₆ "	2 ¹ / ₈ "
G Dia.	5/8"	1"	1 ¹ / ₄ "
N	3 ¹ / ₈ "	5"	6"
U	7 ³ / ₄ "	9 ¹ / ₈ "	9 ¹ / ₈ "
V	3"	3"	3 ¹ / ₄ "
Z	4 ⁷ / ₈ "	4 ⁷ / ₈ "	4 ⁷ / ₈ "
WD	4"	4"	4"
Min. Radius	3'	4'	4'
Standard Flange Width Adjust.	3" - 5"	3 ⁵ / ₈ " - 6"	4" - 6 ¹ / ₄ "

If using a NEMA 4/12 panel, consult factory for dimensions due to add-on of counterweights.

Yale® Options & Accessories



HOOK SUSPENSION
Standard on all electric hoists. Hook suspension provides portability allowing the hoist to be moved throughout a facility.



HEAVY DUTY RIGID MOUNT TROLLEYS FOR HEAVY DUTY SERVICE TRAVERSE APPLICATIONS
Designed for use specifically with Yale lug mounted electric chain hoists. The wheels are heat treated forged steel with dual tread design for operation on either "S" or wide flange beams. Sealed precision ball bearings and heavy gauge steel side plates provide a heavy duty unit.



LINK CHAIN
Link chain hoists are ideally suited for applications requiring heavier capacities, faster hoisting speeds and/or heavier duty cycles.



LUG SUSPENSION BRACKETS
Used to convert hoists from hook to lug suspensions, link chain only. Must be used to accommodate rigid mount push, hand-gear, and motor-driven trolleys.



LUG SUSPENSION
Lug suspension is optional and provides shorter head-room than hook suspension. Lug suspension is available only for link chain hoists and motor-driven trolleys must use lug suspension.



PUSH-BUTTON STATION
All motions can be controlled from a convenient, easy to operate NEMA 4X push-button station. Push-button stations are available for one and two speed, or variable frequency applications.



ROLLER CHAIN
Roller chain hoists run quieter than link chain hoists but are intended for light to medium duty cycle applications



CABLE REELS
Spring loaded reels keep power conductor cables taut and out of the way. Suitable for use with Yale and other electric hoists and trolleys. Cable reel is stationary type with a 340° pivot base.

Yale® Options & Accessories



CABLE SUSPENDED FESTOONING

Cable suspended festoon cross conductor systems are an effective way to electrify short span monorails, bridge cranes, and jib cranes.



SHIELDED BAR CONDUCTORS
Shielded figure "8" bar conductor systems are designed to meet average conductor requirements for cross conductor and runway systems up to 300' long without engineering or layout expense.



TRACK SUSPENDED FESTOONING

An efficient and economical way to electrify longer span, heavier duty crane bridges and monorail systems. Also available for festoon pendant control stations



VARIABLE FREQUENCY DRIVES
Variable frequency drives provide smooth ramped acceleration and deceleration and precise load spotting while lessening impact on the drive train and allowing the motor to run cooler. They are available for all Yale electric chain hoists.



CURRENT COLLECTORS

Slide-type collectors are used for shielded figure "8" conductor bar systems. Collector arrangements typically consist of a collector pole and mounting plate with one collector shoe for each conductor in the conductor system.



CHAIN CONTAINERS

Chain containers eliminate hanging tail chains by providing a storage container for the chain. They are easily installed and accept the chain in a way that will not kink or twist the chain.

AVAILABLE OPTIONS & ACCESSORIES

- TROLLEY ELECTRICAL ADAPTER KITS
Field conversion kit when it is desired to modify existing lug mount hoists for push and hand-gear trolleys to lug mount for motor-driven trolleys.
- TROLLEY ADAPTER LINKS
Make it possible to hang hook mounted hoists on trolleys of larger capacities
- CONDUCTOR CORD TROLLEYS
For supporting conductor cords along the monorail beam.
- WATERPROOF COVERS
Recommended for electric hoists subjected to outdoor usage.
- WEATHERPROOFING
Including weatherproof cord grips, sealing of electrical joints and zinc-plated load chain.
- CORROSION RESISTANT / PLATING SERVICES
Including zinc-plated load chain and hooks, zinc-plated or anodized lower block, zinc chromate primer, motor shaft seal and sealing of electrical joints.

- RETRACTILE CORD
Keeps power cord from dragging, neoprene jacketed, 20'-0" extended length.
- MAINLINE DISCONNECT PANEL
Including trolley mounted disconnect, stop-start buttons on push-button, hoist and trolley fusing
- NEMA 4 & 3R TROLLEY CONTROLS ARE AVAILABLE
- ADDITIONAL POWER SUPPLY CABLE
- TWO SPEED TROLLEYS
3:1 reduction of speeds.
- TROLLEY BRAKE
- ELECTRONIC ACCELERATION CONTROL AND BALLAST RESISTORS
For cushioned starting.
- FUSE PANEL

HOW TO DETERMINE YOUR HOIST REQUIREMENTS

Hoist Capacity

Determine the maximum load to be lifted. If the load falls between standard rated capacities, always go to the higher capacity. (i.e., for 4,300 lb. maximum load, use 6,000 lb., 3 ton capacity hoists.)

Hoist Lift

To determine the total lift required, measure the distance from the bottom of the beam to the lowest point on the floor to be reached and subtract the hoist headroom dimension shown in the specifications. The remaining distance is the lift required on the hoist. Always select a standard lift equal to or greater than the distance required.

Hoist Suspension

Hook type suspension allows hoist to be hung almost anywhere and is used when hoist must be readily moved to other locations. Lug type saves headroom and is used with rigid mount trolleys or when hoist is permanently mounted in a fixed location.

Trolley Type

There are three standard trolley types that can be used to suspend Yale® Hoists.

Push Trolley -Recommended for light capacities and lifts below 20 feet. An economical method for moving loads.

Hand-Geared Trolley -Offers most precise control for load spotting. Most favorable for higher capacities and short monorails where the control is desired. Also recommended where lifts are above 20 feet.

Motor-Driven Trolley -Most widely used method of suspension, particularly 2 ton capacity and above. Virtually a necessity where long monorails are used.

HOW TO SELECT THE CORRECT YALE ELECTRIC HOIST

First– Determine amount of travel /lift required per hour

This can easily be done by taking the distance a load must be lifted and lowered then multiplying by the number of times this must be done per hour to do the job required. Always use maximums that can be expected to occur. Example: Must lift pipe six feet to rack then lower hook for the next load 20 times per hour.

Second– Count the number of starts needed per hour

“Starts” are the actuations of the push-buttons. In our example, let’s assume, under a maximum condition, that in the raise cycle the hoist push-buttons are actuated six (6) times– in the lowering cycle, five (5) times. The number of starts per hour are calculated as follows.

Third– Calculate maximum load and average load

Maximum load is the highest load to be lifted and must not exceed the hoist rating. To arrive at an average load weight, take one up and down cycle (the heaviest anticipated), add the load on the hook in the up direction and the load on the hook in the down direction. Divide this sum by (2) and you will have the average load condition. Using 3,300 pounds and a below-the-hook weight of 300 pounds, average load is calculated as follows:

	Travel/Lift	Starts Per Hour	Average Load
up	6'	6	3600 lbs. Max. Load
down	6'	5	0
total	12'	11	3600
	x 20	x 20	÷ 2
Cycles/Hour	240	220	1800 lbs. Avg. Load

Be sure to include weight of below-the-hook lifting devices. All Yale Electric Hoists figures are based on the average load not exceeding 65% of the rated capacity of the hoist.

Fourth— Select the basic hoist

From our calculations, we know that we need a hoist that will lift a maximum load of 3,600 lbs., move the load 240' per hour with 220 push-button starts, and whose average load is 1,800 lbs. From the following table you can select the proper hoist to do the job:

Note: Average load is used in lieu of the correct **Mean Equivalent Load** for simplification: See ANSI/ASME HST-1M “Performance Standard for Electric Chain Hoists.”

YALE® HOIST RATINGS			
Hoist Type	Hoist Duty Class	Max. No. Starts Hr.	Max. On Time Min/Hr.
Single Phase	H4	300	30 (50%)
Three Phase (HD)	H4	300	30 (50%)
Three Phase (Corrosion Resistant)	Special	700	42 (70%)

Note: The above chart is for single speed models only. On two speed hoists, the high speed winding is rated for HMI class H4 heavy duty, the low speed winding is rated for HMI class H3 standard duty (25% running time) service.

Continuing our example, we have selected a Catalog No. KELB2-10TH16S2 heavy duty hoist (2-ton capacity, 10-foot lift, 16 FPM lifting speed).

	Requirement	KELB2-10TH16S2
Travel/Lift	240'	16 FPM x 30 min. = 480 Ft.
Starts	220	300
Avg. Load	1800 lbs	2600 lbs*
Max. Load	3600 lbs.	4000 lbs

* 65% at rated capacity of 4000 lbs. per ANSI/ASME HST-1M

As shown in the chart above, three phase hoists give superior performance and should be used whenever that power is available. Single phase, while universally available, should be limited to applications where infrequent lifting is the rule.

See ANSI/ASME HST-1M “Performance Standard for Electric Chain Hoists.”

If you follow this simple method of hoist application, you will never buy more hoist than you need, you can be sure the hoist will perform the required duty and you won't find yourself on the short end of application versus hoist.

The duty rating as described will meet or exceed most industrial applications. Where the duty cycle is anticipated to exceed this duty rating, contact your Yale® field representative or the factory at Muskegon, Michigan for the hoist to meet your need.

OSHA Compliance

The Yale® electric hoist and trolleys are built in accordance with the specifications herein and at the time of manufacture, comply with our interpretation of applicable sections of ANSI/ASME B30.16 “Overhead Hoists”. National Electric Code ANSI CI (NFPA70) and Occupational Safety and Health Act, 1970.

OSHA places the burden of compliance for hoist installations on the user. The user must install the equipment in accordance with the National Electric Code CL as well as other federal, state and local regulations which apply to the installation and application in your particular area.

NOTE: Equipment covered herein is not designed or suitable as a power source for lifting, lowering or supporting persons.

 WARNING
Overloading and improper use can result in injury
To avoid injury:
<ul style="list-style-type: none"> • Do not exceed working load limit, load rating or capacity. • Do not use to lift people or loads over people. • Use only alloy chain and attachments for overhead lifting. • Read and follow all instructions.

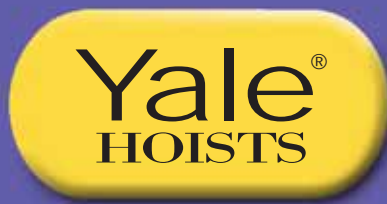

For additional information contact your Yale representative or Yale headquarters direct.

414 West Broadway Ave. • P.O. Box 769 • Muskegon, MI 49443
PH: 800-999-6318 • FX: 800-766-0223

⚠ WARNING

- To Avoid Injury:
- Do not exceed working load limit, load rating, or capacity.
 - Do not use to lift people or loads over people.
 - Read and follow all instructions.

PRINTED IN U.S.A. / COPYRIGHT 2000, YALE® HOISTS, DIVISION OF COLUMBUS MCKINNON CORPORATION / BULLETIN NO Y/L-1006-1100

